

GX41: for quick inspections at the production site.

Compact, practical design offering all necessary functions for inspecting metallurgical samples, large metal parts and electronic components.

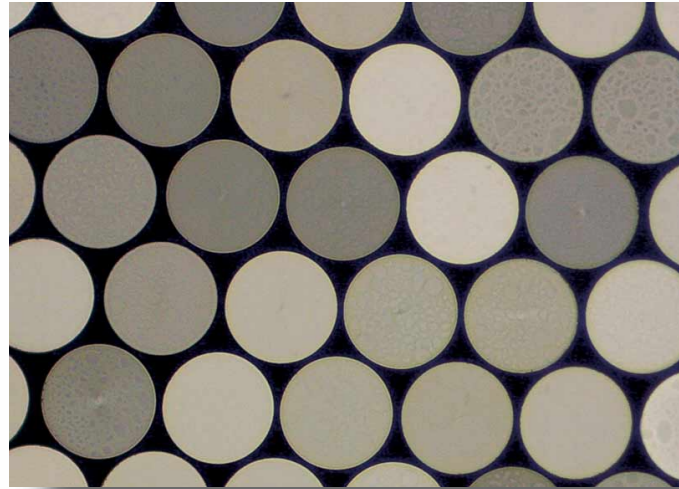

Fiber end section

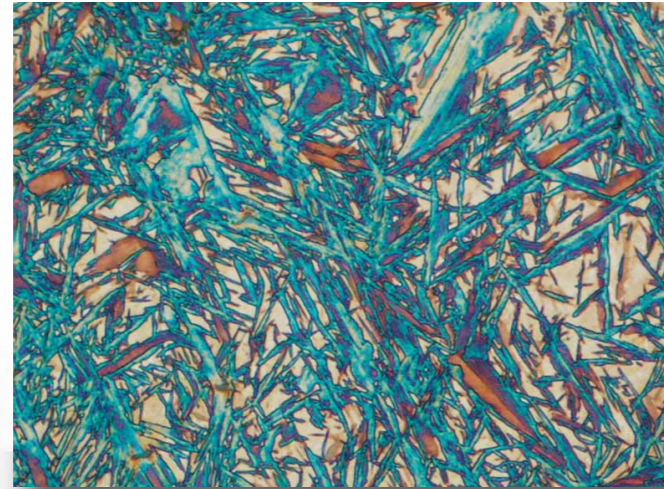

Martensite and retained austenite



GX41 specifications

Optical system	UIS2 optical system (infinity-corrected system)	
Observation method	Reflected light brightfield observation, reflected light simple polarizing observation	
Focus	Vertical revolving nosepiece movement (fixed stage), coarse and fine handles (with torque adjustment), roller guide movement. Stroke (from 1 mm above focusing position from stage surface) Upward: 7 mm, Downward: 2 mm Stroke per coarse handle rotation: 36.8 mm, Stroke per fine handle rotation: 0.2 mm	
Revolving nosepiece	Quadruple revolving nosepiece	
Stage	Plane stage	Size: 160 (W) x 250 (D) mm, stage insert plate type (no accessories)
	Mechanical stage	Stroke: 120 mm (X) x 78 (Y) mm Coaxial handle: attachable to right/left side of plane stage Use special stage plate CK40M-CP to observe samples up to ø50 mm.
Illumination	Illuminator	Built-in aperture diaphragm (Lever operation type) Various ø25 mm filters can be inserted
	Light source	6 V 30 WHAL-L: long-life halogen lamp 6 V 30 WHAL: High intensity halogen lamp Rated power output: 6 V-30 VA Rated input voltage, current and frequency: 100-120 V/220-240 V-0.85/0.45 A, 50/60 Hz
Observation tube	Eyepieces: Attached to microscope body (F.N. 18)	U-CTBI (tilting tube) Inclination angle: 30°-60°, adjustable interpupillary distance range: 48-75 mm
	Eyepieces: WHB10X, WHB10X-H (F.N. 20)	U-CBI30-2 (binocular tube), U-CTR30-2 (trinocular tube) Inclination angle: 30°, interpupillary distance: 48-75 mm
	Eyepieces: WHN10X, WHN10X-H, CROSSWHN10X (F.N.22)	U-BI30-2 (binocular tube), U-TR30-2 (trinocular tube) Inclination angle: 30°, interpupillary distance: 50-76 mm U-TBI-3 (tilting binocular tube) Inclination angle: 5°-35°, interpupillary distance: 50-76 mm
Intermediate attachments	U-CA, GX-SPU, U-ECA, U-DA, U-DO3	
Electrical components	Continuous light intensity volume adjustment, built-in voltage exchange switch	
Power consumption	Maximum power consumption: 85 VA 40 W	
Dimensions	236 (W) x 24 (D) x 407 (H) mm (binocular tube)	
Weight	Approx.10 kg	

GX41 dimensions

(unit: mm)

Stage plate CK40M-CP 1:1 illustration

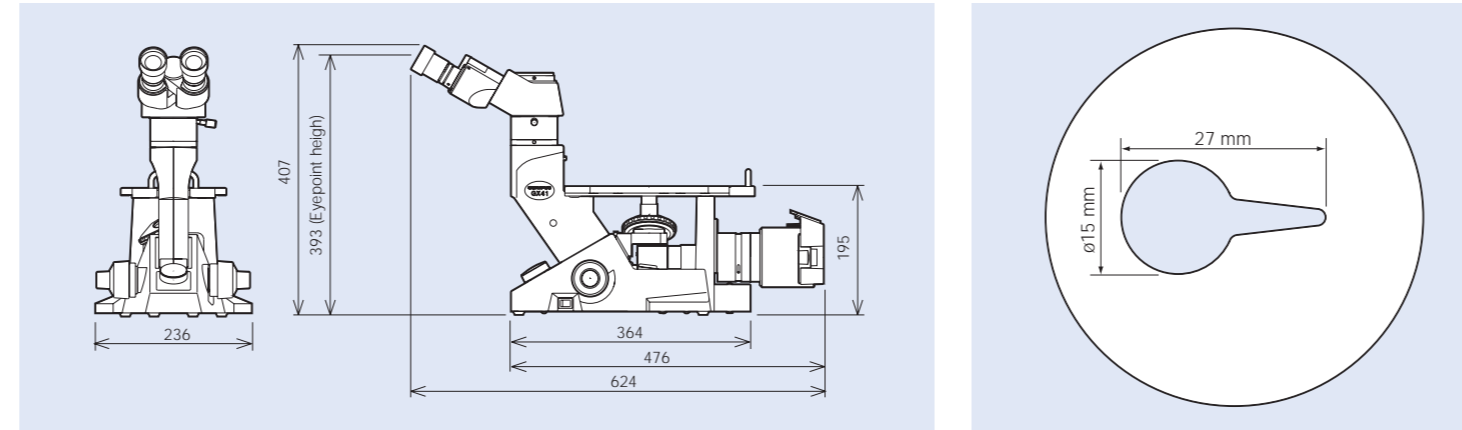

- OLYMPUS CORPORATION is ISO14001 certified.
- OLYMPUS CORPORATION is FM553994/ISO9001 certified.
- Illumination devices for microscope have suggested lifetimes. Periodic inspections are required. Please visit our web site for details.
- Images on the PC monitors are simulated.
- Specifications and appearances are subject to change without any notice or obligation on the part of the manufacturer.



New advances in both imaging and functionality.

Featuring the brighter, clearer visibility of UIS2 optics, and the convenience of observation with instant image recording.

Clear, bright observation at all magnification levels.

- Newly improved inspection efficiency thanks to UIS2 infinity-corrected optics, which allow high-clarity observation with flat, bright, even images right to the edge of the visual field (F.N.22)*.

* When using eyepiece WHN10x series.

- To meet high-magnification observation requirements, magnification settings extend from 5x to 100x.



- Suitable for both brightfield and simple polarizing observations. The polarizer can be rotated through 90°, allowing optimum contrast control.

- As well as the standard 6 V, 30 W halogen lamp, users can select a 100 W fiber light source, high-brightness images, even of dark samples.

- Reflected light illuminator with aperture stop. Optimum contrast is obtained according to objective lens magnification and observation method. Handy filter pockets are provided, as various types of ø25 filters can be used besides the polarizer.

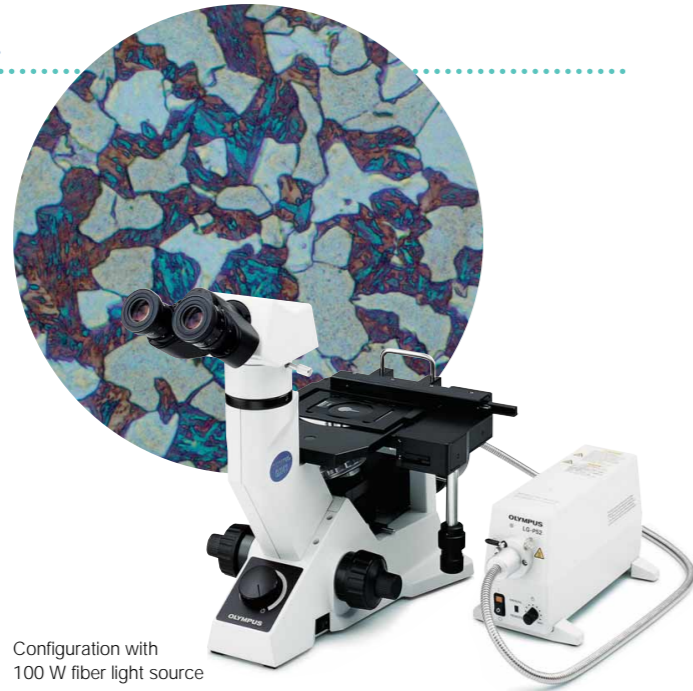

Configuration with 100 W fiber light source

Easy observations while standing or sitting.

- Different types of tilting binoculars are available, so the tilting angle can be freely changed. Observations can be made quickly and easily, even while standing.

- The 6 V, 30 W halogen lamp is pre-centered, making manual centering unnecessary.

- The coaxial coarse and fine focus handle enables focusing without changing hands.

- The revolving nosepiece accepts four objective lenses, allowing quick exchange among them.

- With the optional stage mirror (CK40M-MS) attached, the user can easily confirm the observation position of the sample (and the objective lens in use) by only a slight shift of the eye, from the eyepiece to the mirror.

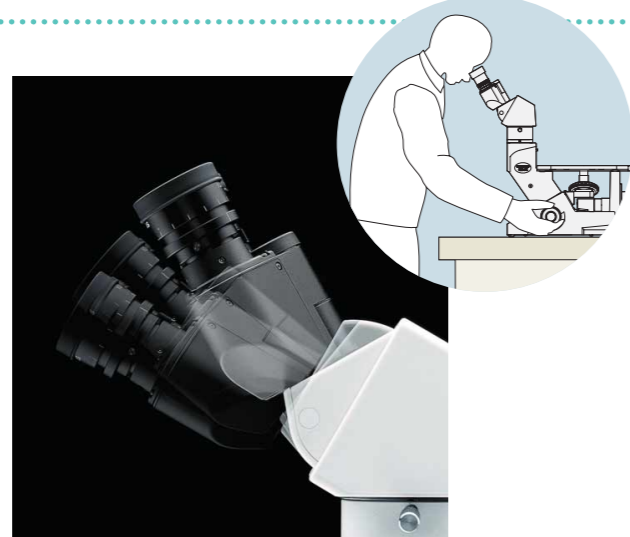

Any size of sample can be comfortably observed.

- The plane stage enables observation of thicker/larger samples (more than ø50 mm), while the mechanical stage allows extremely precise movements.

- The mechanical stage is attached to the left/right side of the plane stage, according to the operator's dominant hand. A stage plate and plate holder are included.

- A special stage insert plate (IX-CP50) is provided for samples of over ø100 mm diameter.

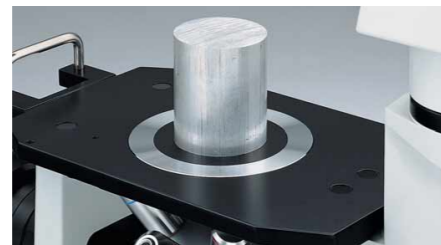

Fast, easy image recording.

- Users can attach a digital microscope camera or a video camera via an intermediate attachment or trinocular tube.



Configuration: GX41 with a microscope digital camera

Easy installation by the production line and easy to carry.

- The compact, easy-to-use GX41 can be installed in a limited space, making it suitable for on-the-spot inspections close to production lines.

- Light and easy to carry, the GX41 is ideal for moving between manufacturing site, classroom or practice location.



Easy system expansion according to need.

- UIS2 optics are especially suitable for system expansion. Using optional intermediate attachments does not cause any image deterioration.

- The GX-SPU adapter enables attachment of a digital camera or video camera while using the binocular tube.

- Dual observation attachment U-DO3 allows two people to observe the same image at the same time.

- Intermediate magnification changers U-CA (1.25x, 1.6x, 2x) and U-ECA (2x) let users select intermediate magnifications without changing objective lenses.



- Drawing attachment U-DA enables easy, accurate drawing; the tip of the pen can be seen through the binocular tube.



U-DO3 configuration

U-DA configuration

Quick compliance with various kinds of measurements, e.g. grain size.

- An eyepiece micrometer and grain scale are provided. (Please contact your nearest Olympus dealer for details)

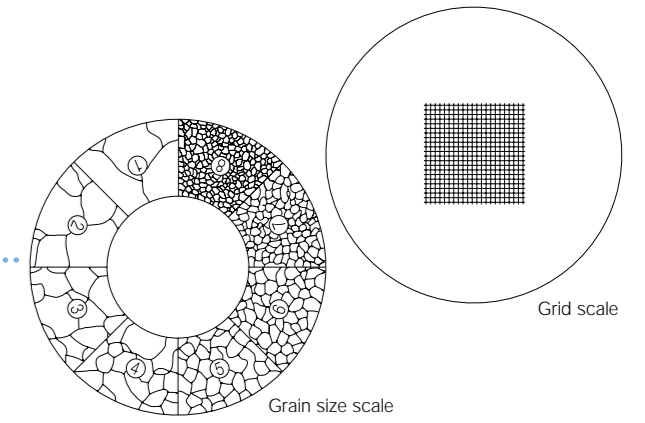

SYSTEM DIAGRAM

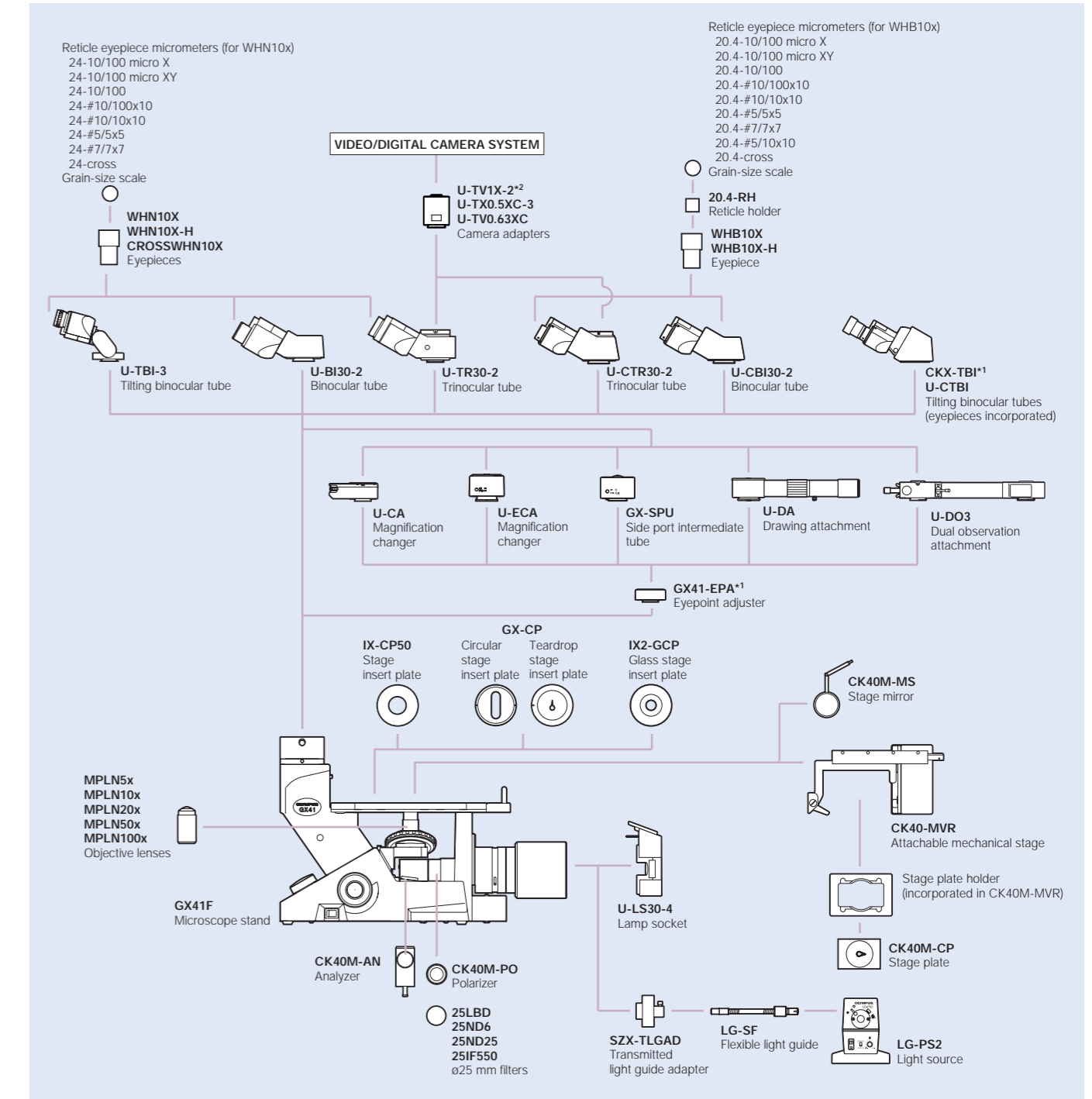

¹ When combining GX41-EPA or CKX-TBI, disconnect the adapter attached to GX41F. ² An additional mount adapter is required.